

# DOTCO®



**Extreme performance  
is now available in an  
ergonomic family of drills.**



## CONFIGURED FOR YOUR ENVIRONMENT & APPLICATION

Cleco MP Series Drills are Industrial grade medium duty drills suitable for a wide range of production and MRO applications. Cleco® Dotco™ pneumatic drills are Industrial high duty grade and are used daily in applications ranging from appliances to aerospace manufacturing. Offered in a variety of configurations, including pistol grip, inline, and right angle, Dotco air drills are designed for the high-volume, high-repetition, high-precision demands of today's assembly lines. Whether a spindle, chuck, motor or angle head, our interchangeable parts allow operators the versatility they need for a range of industrial and manufacturing applications.

## PARTS INTERCHANGEABILITY

Maintenance of tools can be time consuming and expensive. That is why our products have been designed with high parts interchangeability. With fewer parts required to repair our tools, less inventory of parts is required and tools are easier to repair.

## PRECISION PARTS

It's simple, precision parts let operators manufacture precision products. Whether it is a spindle, a chuck, a motor or an angle head, our parts are manufactured from the finest materials available and are machined to the highest tolerances.

## ULTIMATE ERGONOMICS

Dotco drills have long been the industry workhorse for the high-volume, high-repetition, high-precision demands of today's assembly line. Dotco drills are the ergonomic solution to deliver comfort and productivity, while assuring decreased operator fatigue, potential for injury and downtime on the line.

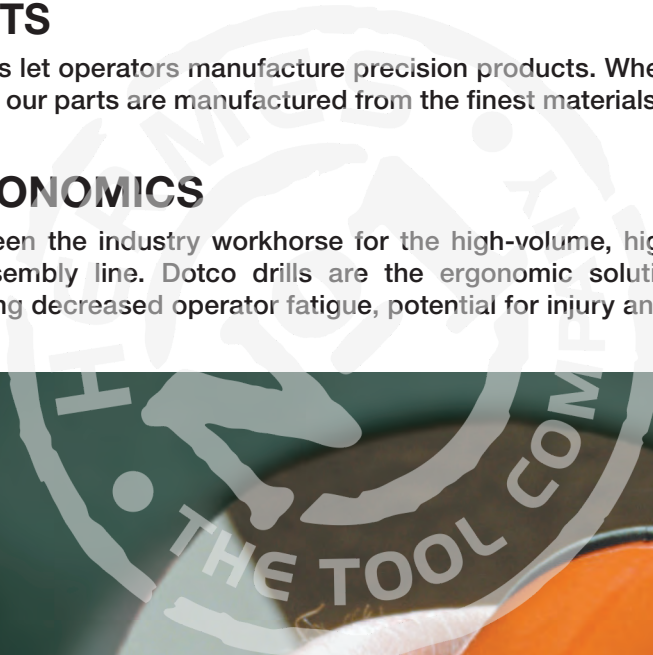

Design features double ball bearings for the spindle, pre-loaded for longer bearing life and more accurate spindle control. Vibration and runout are reduced.

Gears are machined from alloy steel and heat-treated, with fixed cages to control centers for smooth operation.

Time-proven motor and gear design is well-balanced to reduce vibration and extend tool life.

Each tool is individually checked, aligned and adjusted on our assembly line for minimum chuck runout. Vibration is minimized.

Ergonomically critical finger and thumb guides fit the hand and aid in control.

The trigger is practically forceless requiring only 4 ounces of pressure to engage.

Finger lip under the trigger keeps other fingers from interfering with the trigger action.

Housing is made of durable lightweight industrial grade aluminum.

Full feathering is accomplished with our pressurized tip-valve design for speed control while drilling.

Rubber grip acts as a thermal protector and isolates vibration for improved operator comfort.

Handles are shaped to fit the human hand. They are flat where they need to be flat and round where they need to be round ensuring less slippage.

Minimal noise levels enhance operator comfort.

Pistol Grip Drills  
Page 58



Inline Drills  
Page 62



Right Angle Drills  
Page 62



## 14CF Series - Non-Reversible

600 - 29,000 RPM 0.4 hp (0.30 kW)

- 600 - 29000 rpm
- 0.4 hp / 0.30 kW
- Supplied with Jacobs® Keyed Chuck or Threaded Termination for Keyless Chuck/Collet - see options on page 67.
- Non-reversible
- Composite grip with ergonomic finger and thumb guides to aid control
- Excellent for aerospace, metal fabrication, and woodworking applications



Termination			Free Speed (rpm)	Weight	Length	Air Inlet Size
1/4" Chuck	3/8" Chuck	3/8"-24 e				
Cat. No.	Cat. No.	Cat. No.				
14CFS97-38	14CFS97-51	14CFS97-40	600	1.8 lb   0.82 kg	6.9 in   175 mm	1/4 in
14CFS96-38	14CFS96-51	14CFS96-40	700	1.8 lb   0.82 kg	6.9 in   175 mm	1/4 in
14CFS95-38	14CFS95-51	14CFS95-40	1,000	1.8 lb   0.82 kg	6.9 in   175 mm	1/4 in
14CFS94-38	14CFS94-51	14CFS94-40	2,400	1.6 lb   0.73 kg	5.7 in   145 mm	1/4 in
14CFS93-38	14CFS93-51	14CFS93-40	3,200	1.5 lb   0.68 kg	5.7 in   145 mm	1/4 in
14CFS92-38	14CFS92-51	14CFS92-40	3,800	1.5 lb   0.68 kg	5.7 in   145 mm	1/4 in
14CFS91-38	14CFS91-51	14CFS91-40	5,200	1.5 lb   0.68 kg	5.7 in   145 mm	1/4 in
14CFS90-38	14CFS90-51	14CFS90-40	29,000	1.5 lb   0.68 kg	5.7 in   145 mm	1/4 in

All tools performance rated @ 90 psi / 620 kPa air pressure.

Minimum Hose I.D.: 5/16 in / 7.9 mm

Drill Diameter Capacity Matches Chuck Size

## 14CS Series - Non reversible

500 - 20,000 RPM 0.6 hp (0.45 kW)

- 500 - 20000 rpm
- 0.6 hp / 0.45 kW
- Supplied with Jacobs® Keyed Chuck or Threaded Termination for Keyless Chuck/Collet - see options on page 67.
- Composite grip with ergonomic finger and thumb guides to aid control
- Excellent for aerospace, metal fabrication, and woodworking applications



Termination			Free Speed (rpm)	Weight	Length	Air Inlet Size
3/8" Chuck	3/8" - 24 e	1/4" Chuck				
Cat. No.	Cat. No.	Cat. No.				
14CSL97-51	14CSL97-40	—	500	2.9 lb   1.32 kg	8.1 in   206 mm	1/4 in
14CSL95-51	14CSL95-40	—	1,300	2.9 lb   1.32 kg	8.1 in   206 mm	1/4 in
—	14CSL92-40	14CSL92-38	3,200	2.1 lb   0.95 kg	6.3 in   160 mm	1/4 in
—	14CSL91-40	14CSL91-38	5,200	2.1 lb   0.95 kg	6.3 in   160 mm	1/4 in
—	14CSL98-40	14CSL98-38	6,000	2.1 lb   0.95 kg	6.3 in   160 mm	1/4 in
—	14CSL90-40	14CSL90-38	20,000	2.1 lb   0.95 kg	6.3 in   160 mm	1/4 in

All tools performance rated @ 90 psi / 620 kPa air pressure.

Minimum Hose I.D.: 5/16 in / 7.9 mm

Standard equipment: Jacobs geared chuck, chuck key

Drill diameter capacity matches chuck size.

## 14CNL Series - Non-Reversible

500 - 20,000 RPM 0.9 hp (0.67 kW)

- 500 - 20000 rpm
- 0.9 hp / 0.67 kW
- Supplied with Jacobs® Keyed Chuck or Threaded Termination for Keyless Chuck/Collet - see options on page 67.
- Composite grip with ergonomic finger and thumb guides to aid control
- Excellent for aerospace, metal fabrication, and woodworking applications
- 1/2" models equipped with dead handle



Termination				Free Speed (rpm)	Weight	Length	Air Inlet Size
3/8" Chuck	3/8" - 24 e	1/2" Chuck	1/4" Chuck				
Cat. No.	Cat. No.	Cat. No.	Cat. No.				
14CNL97-51	14CNL97-40	14CNL97-53	—	500	3.5 lb   1.59 kg	9.1 in   231 mm	1/4 in
14CNL95-51	14CNL95-40	—	—	1,300	2.8 lb   1.27 kg	8.6 in   218 mm	1/4 in
14CNL92-51	14CNL92-40	14CNL92-53	14CNL92-38	3,200	2.4 lb   1.09 kg	7.2 in   183 mm	1/4 in
14CNL91-51	14CNL91-40	—	—	5,200	2.4 lb   1.09 kg	7.2 in   183 mm	1/4 in
14CNL98-51	14CNL98-40	14CNL98-53	14CNL98-38	6,000	2.2 lb   1.00 kg	6.8 in   173 mm	1/4 in
—	14CNL90-40	—	14CNL90-38	20,000	2.2 lb   1.00 kg	6.8 in   173 mm	1/4 in

All tools performance rated @ 90 psi / 620 kPa air pressure.  
 Minimum Hose I.D.: 5/16 in / 7.9 mm  
 Standard equipment: Jacobs geared chuck, chuck key  
 Drill diameter capacity matches chuck size.

## 14CHL Series - Non-Reversible

3,200 – 6,000 RPM 1.4 hp (1.0 kW)

- 3200 - 6000 rpm
- 1.4 hp / 1.0 kW
- Supplied with Jacobs® Keyed Chuck or Threaded Termination for Keyless Chuck/Collet - see options on page 67.
- Powerful motor
- Rear exhaust



Cat. No.	Termination	Free Speed (rpm)	Weight	Length	Air Inlet Size
14CHL92-38	1/4" Chuck	3,200	2.6 lb   1.18 kg	6.5 in   165 mm	1/4 in
14CHL92-40	3/8" - 11 e	3,200	2.4 lb   1.09 kg	5.5 in   140 mm	1/4 in
14CHL92-51	3/8" Chuck	3,200	2.8 lb   1.27 kg	7.1 in   180 mm	1/4 in
14CHL92-53	1/2" Chuck	3,200	3.8 lb   1.72 kg	7.4 in   188 mm	1/4 in
14CHL98-38	1/4" Chuck	6,000	2.6 lb   1.18 kg	6.5 in   165 mm	1/4 in
14CHL98-40	3/8" - 11 e	6,000	2.4 lb   1.09 kg	5.5 in   140 mm	1/4 in
14CHL98-51	3/8" Chuck	6,000	2.8 lb   1.27 kg	7.1 in   180 mm	1/4 in
14CHL98-53	1/2" Chuck	6,000	3.8 lb   1.72 kg	7.4 in   188 mm	1/4 in

All tools performance rated @ 90 psi / 620 kPa air pressure.  
 Drill Diameter Capacity Matches Chuck Size  
 Minimum hose ID: 5/16 in / 7.9 mm

PISTOL GRIP DRILLS

## 15DP Series - Non-Reversible

160 – 1,400 RPM 1.0 hp (0.75 kW)

- 160 - 1400 rpm
- 1.0 hp / 0.75 kW
- Excellent for slow speed application
- Powerful motor



Cat. No.	Termination	Free Speed (rpm)	Weight	Length	Air Inlet Size
15DP-1.6B-53	1/2" Chuck	160	6.0 lb   2.72 kg	9.8 in   249 mm	3/8 in
15DP-4B-53	1/2" Chuck	400	5.5 lb   2.49 kg	8.5 in   216 mm	3/8 in
15DP-8B-53	1/2" Chuck	800	5.5 lb   2.49 kg	8.5 in   216 mm	3/8 in
15DP-14B-49	3/8" Chuck	1,400	4.5 lb   2.04 kg	8.3 in   211 mm	3/8 in

All tools performance rated @ 90 psi / 620 kPa air pressure.

Standard Equipment: Operating instructions and service manual Dead handles on all models except 15DP-14B 3-Jaw Chuck and Key

General: Air Inlet: 3/8" NPTF, Minimum Hose Size: 3/8", Spindle Thread: 1/2"-20, Spindle Offset: Pistol Grip: 31/32"

Drill Diameter Capacity Matches Chuck Size

Minimum hose ID: 5/16 in / 7.9 mm

## 135DPV Series - Variable Speed

1,350 RPM 0.7 hp (0.5 kW)

- 150 - 2600 rpm
- 0.7 hp / 0.5 kW
- Variable speed
- Calibrated governed speed control



Cat. No.	Termination	Free Speed (rpm)	Weight	Length	Air Inlet Size	Governed RPM Range
135DPV-7B-43	1/2" Chuck	600	3.6 lb   1.63 kg	9.6 in   244 mm	1/4 in	150 - 550
135DPV-7B-50	1/2" Chuck	600	3.6 lb   1.63 kg	9.6 in   244 mm	1/4 in	150 - 550
135DPV-14B-50	1/2" Chuck	1,250	3.4 lb   1.54 kg	9.3 in   236 mm	1/4 in	400 - 1,200
135DPV-14B-51	3/8" Chuck	1,250	3.4 lb   1.54 kg	9.3 in   236 mm	1/4 in	400 - 1,200
135DPV-28B-51	3/8" Chuck	2,600	3.2 lb   1.45 kg	8.5 in   216 mm	1/4 in	700 - 2,400

All tools performance rated @ 90 psi / 620 kPa air pressure.

Standard Equipment: Operating instructions, service manual, 3-Jaw Chuck and Key-Jaw Chuck and Key

General: Air Inlet: 1/4 in NPT, Minimum Hose Size: 1/4 in / 6 mm, Spindle Offset: 25/32 in / 20 mm

Drill Diameter Capacity Matches Chuck Size

## MP Series - MP1457-51

2,600 RPM 1.0 hp (0.75 kW)

- Non-reversible
- Double row ball bearings on output spindle for excellent alignment and true running bits
- Steel front end for industrial applications
- 2-step throttle for easy starts
- Built-in, no-clog mufflers for quiet operation
- Hardened and ground precision parts for extended service life
- Industrial grade medium duty drills are suitable for a wide range of production and MRO applications



## MP Series - MP1463-51

1,800 RPM 1.0 hp (0.75 kW)

- Reversible
- Ball bearings on output spindle for excellent alignment and true running bits
- Steel front end for industrial applications
- 2-step throttle for easy starts
- Built-in, no-clog mufflers for quiet operation
- Hardened and ground precision parts for extended service life
- Industrial grade medium duty drills are suitable for a wide range of production and MRO applications



## MP Series - MP1458-55

1,200 RPM 1.2 hp (0.90 kW)

- Non-reversible
- Ball bearings on output spindle for excellent alignment and true running bits
- Steel front end for industrial applications
- 2-step throttle for easy starts
- Built-in, no-clog mufflers for quiet operation
- Hardened and ground precision parts for extended service life
- Industrial grade medium duty drills are suitable for a wide range of production and MRO applications



Model Number	Free Speed	hp	Chuck Capacity	Length		Weight		Spindle Offset		Air Inlet
	RPM			in	mm	lbs	kg	in	mm	
MP1457-51	2600	1.0	3/8 in	7.5	191.0	1.9	0.85	0.84	20.6	1/4 in
MP1463-51	1800	1.0	3/8 in	6.8	172.7	2.5	1.1	0.84	20.6	1/4 in
MP1458-55	1200	1.2	1/2 in	9.0	228.6	2.1	0.95	0.84	20.6	1/4 in

**General:**

Air Inlet: 1/4" NPT – Use 1/4" (6.4 mm) I.D. hose

All tools performance rated @ 90psi (620 kPa) air pressure

**Standard Equipment:**

Chuck and Key  
Owners Manual  
Parts Sheet

## 15LF Series - Inline

600 - 28,500 RPM 0.4 hp (0.30 kW)

- Optional Jacobs® geared chuck
- Safety lever



Exhaust		Termination	Free Speed (rpm)	Type Housing	Weight	Length	Air Inlet Size
Rear	Front						
Cat. No.	Cat. No.						
15LF087-38	—	1/4" Chuck	600	Composite	1.9 lb   0.86 kg	8.6 in   218 mm	1/4 in
15LF087-40	—	3/8" - 24 e	600	Composite	1.9 lb   0.86 kg	8.6 in   218 mm	1/4 in
15LF086-38	—	1/4" Chuck	750	Composite	1.4 lb   0.64 kg	8.0 in   203 mm	1/4 in
—	15LF055-38	1/4" Chuck	1,000	Composite	1.9 lb   0.86 kg	8.6 in   218 mm	1/4 in
15LF085-38	—	1/4" Chuck	1,000	Composite	1.4 lb   0.64 kg	8.0 in   203 mm	1/4 in
15LF085-40	—	3/8" - 24 e	1,000	Composite	1.4 lb   0.64 kg	8.0 in   203 mm	1/4 in
—	15LF054-38	1/4" Chuck	2,400	Composite	1.3 lb   0.59 kg	7.3 in   185 mm	1/4 in
15LF084-38	—	1/4" Chuck	2,400	Composite	1.4 lb   0.64 kg	8.0 in   203 mm	1/4 in
—	15LF053-38	1/4" Chuck	3,300	Composite	1.3 lb   0.59 kg	7.3 in   185 mm	1/4 in
15LF083-38	—	1/4" Chuck	3,300	Composite	1.4 lb   0.64 kg	8.0 in   203 mm	1/4 in
15LF083-40	—	3/8" - 24 e	3,300	Composite	1.4 lb   0.64 kg	8.0 in   203 mm	1/4 in
—	15LF052-38	1/4" Chuck	4,000	Composite	1.3 lb   0.59 kg	7.3 in   185 mm	1/4 in
15LF082-38	—	1/4" Chuck	4,000	Composite	1.4 lb   0.64 kg	8.0 in   203 mm	1/4 in
15LF082-40	—	3/8" - 24 e	4,000	Composite	1.4 lb   0.64 kg	7.3 in   185 mm	1/4 in
—	15LF051-38	1/4" Chuck	5,300	Composite	1.3 lb   0.59 kg	7.3 in   185 mm	1/4 in
15LF081-38	—	1/4" Chuck	5,300	Composite	1.4 lb   0.64 kg	8.0 in   203 mm	1/4 in
15LF081-40	—	3/8" - 24 e	5,300	Composite	1.4 lb   0.64 kg	8.0 in   203 mm	1/4 in
15LF080-38	—	1/4" Chuck	28,500	Composite	0.9 lb   0.41 kg	6.3 in   160 mm	1/4 in

All tools performance rated @ 90 psi / 620 kPa air pressure.  
Minimum Hose I.D.: 1/4 in / 6.4 mm  
Standard Equipment: Jacobs geared chuck, chuck key  
Drill diameter capacity matches chuck size.

## 15-14 Series - Right Angle

2,400 - 3,600 RPM 0.3 hp (0.22 kW)

- 2400 - 3600 rpm
- 0.3 hp / 0.22 kW
- Optional Jacobs® geared chuck
- Safety Lever



Cat. No.	Termination	Free Speed (rpm)V	Type Housing	Weight	Length	Head Height	Air Inlet Size	Drill Diameter Capacity
15L1487-32	1/4" - 28 i	1,500	Composite	1.2 lb   0.54 kg	8.0 in   203 mm	3.0 in	1/4 in	1/4 in
15L1487-36	1/4" Collet	1,500	Composite	1.2 lb   0.54 kg	8.0 in   203 mm	3.0 in	1/4 in	1/4 in
15L1487-38	1/4" Chuck	1,500	Composite	1.5 lb   0.68 kg	8.0 in   203 mm	3.0 in	1/4 in	1/4 in
15L1488-36	1/4" Collet	2,400	Composite	1.6 lb   0.73 kg	8.7 in   221 mm	3.0 in	1/4 in	1/4 in
15L1488-38	1/4" Chuck	2,400	Composite	1.5 lb   0.68 kg	8.0 in   203 mm	3.0 in	1/4 in	1/4 in
15L1489-32	1/4" - 28 i	3,600	Composite	1.6 lb   0.73 kg	8.7 in   221 mm	3.0 in	1/4 in	1/4 in
15L1489-36	1/4" Collet	3,600	Composite	1.6 lb   0.73 kg	8.7 in   221 mm	3.0 in	1/4 in	1/4 in
15L1489-38	1/4" Chuck	3,600	Composite	1.5 lb   0.68 kg	8.0 in   203 mm	3.0 in	1/4 in	1/4 in
15L1489-51	3/8" Chuck	3,600	Composite	1.5 lb   0.68 kg	8.0 in   203 mm	3.0 in	1/4 in	1/4 in
15L1470-37	5/32" Chuck	12,000	Composite	1.2 lb   0.54 kg	6.9 in   175 mm	2.5 in	1/4 in	1/4 in
15L1401-37*	5/32" Chuck	20,000	Composite	1.0 lb   0.45 kg	6.2 in   157 mm	2.5 in	1/4 in	1/4 in
15L1471-37	5/32" Chuck	20,000	Composite	1.2 lb   0.54 kg	6.9 in   175 mm	2.5 in	1/4 in	1/4 in

\*Front Exhaust Tool  
All tools performance rated @ 90 psi / 620 kPa air pressure.  
Minimum Hose I.D.: 1/4 in / 6.4 mm

Standard Equipment: Jacobs geared chuck, chuck key  
Drill Diameter Capacity Matches Chuck Size



## 15LF Series - Light Duty Head

600 - 5,300 RPM 0.4 hp (0.30 kW)

- 600 - 5300 rpm
- 0.4 hp / 0.30 kW
- Wide array of speeds, head designs, and spindle threads for all applications
- High efficiency motor and gear train
- Comfortable and ergonomic handle
- Other terminations available (see page 66) -61 10-32 interal thread, -63 threaded collet, -64 5/16 in - 24 thread



Cat. No.	Termination	Free Speed (rpm)	Type Housing	Weight	Length	Air Inlet Size
15LF287-62	1/4" - 28 i	600	Composite	1.9 lb   0.86 kg	11.8 in   300 mm	1/4 in
15LF286-62	1/4" - 28 i	750	Composite	1.9 lb   0.86 kg	11.8 in   300 mm	1/4 in
15LF285-62	1/4" - 28 i	1,000	Composite	1.9 lb   0.86 kg	11.8 in   300 mm	1/4 in
15LF284-62	1/4" - 28 i	2,400	Composite	1.8 lb   0.82 kg	11.1 in   282 mm	1/4 in
15LF283-62	1/4" - 28 i	3,300	Composite	1.6 lb   0.73 kg	10.7 in   272 mm	1/4 in
15LF282-62	1/4" - 28 i	4,000	Composite	1.6 lb   0.73 kg	10.7 in   272 mm	1/4 in
15LF281-62	1/4" - 28 i	5,300	Composite	1.6 lb   0.73 kg	10.7 in   272 mm	1/4 in

All tools performance rated @ 90 psi / 620 kPa air pressure.  
Standard Equipment: 600 Series Mini Angle Head with 1/4"-28 internal thread

## 15LF Series - Heavy Duty Head

420 - 3,700 RPM 0.4 hp (0.30 kW)

- Wide array of speeds, head designs, and spindle threads for all applications
- High-efficiency motor and gear train
- Comfortable and ergonomic handle
- Other terminations available (see page 66) -51 10-32 interal thread, -53 threaded collet, -54 5/16 in - 24 thread



Cat. No.	Termination	Free Speed (rpm)	Type Housing	Weight	Length	Air Inlet Size
15LF287-52	1/4" - 28 i	420	Composite	2.0 lb   0.91 kg	12.0 in   305 mm	1/4 in
15LF286-52	1/4" - 28 i	525	Composite	2.0 lb   0.91 kg	12.0 in   305 mm	1/4 in
15LF285-52	1/4" - 28 i	700	Composite	2.0 lb   0.91 kg	12.0 in   305 mm	1/4 in
15LF284-52	1/4" - 28 i	1,700	Composite	1.8 lb   0.82 kg	10.6 in   269 mm	1/4 in
15LF283-52	1/4" - 28 i	2,300	Composite	1.7 lb   0.77 kg	11.0 in   279 mm	1/4 in
15LF282-52	1/4" - 28 i	2,800	Composite	1.7 lb   0.77 kg	11.0 in   279 mm	1/4 in
15LF281-52	1/4" - 28 i	3,700	Composite	1.7 lb   0.77 kg	11.0 in   279 mm	1/4 in

All tools performance rated @ 90 psi / 620 kPa air pressure.  
Standard Equipment: 500 Series Heavy Duty Angle Head with 1/4"-28

## 15LS Series - Light Duty Head

500 - 5,430 RPM 0.6 hp (0.45 kW)

- Wide array of speeds, head designs, and spindle threads for all applications
- High efficiency motor and gear train
- Comfortable and ergonomic handle
- Other terminations available (see page 66) -61 10-32 interal thread, -63 threaded collet, -64 5/16 in - 24 thread



Cat. No.	Termination	Free Speed (rpm)	Type Housing	Weight	Length	Air Inlet Size
15LS287-62	1/4" - 28 i	500	Composite	1.9 lb   0.86 kg	12.7 in   323 mm	1/4 in
15LS286-62	1/4" - 28 i	840	Composite	1.9 lb   0.86 kg	12.7 in   323 mm	1/4 in
15LS285-62	1/4" - 28 i	1,360	Composite	1.9 lb   0.86 kg	12.7 in   323 mm	1/4 in
15LS284-62	1/4" - 28 i	1,660	Composite	1.9 lb   0.86 kg	12.4 in   315 mm	1/4 in
15LS283-62	1/4" - 28 i	2,010	Composite	2.3 lb   1.04 kg	11.5 in   292 mm	1/4 in
15LS282-62	1/4" - 28 i	3,370	Composite	2.3 lb   1.04 kg	11.5 in   292 mm	1/4 in
15LS281-62	1/4" - 28 i	5,430	Composite	2.3 lb   1.04 kg	11.5 in   292 mm	1/4 in

All tools performance rated @ 90 psi / 620 kPa air pressure.  
Standard Equipment: 600 Series Mini Angle Head with 1/4"-28 internal thread

## 15LN Series - Light Duty Head

540 - 5,600 RPM 0.9 hp (0.67 kW)

- Wide array of speeds, head designs, and spindle threads for all applications
- High efficiency motor and gear train
- Comfortable and ergonomic handle
- Other terminations available (see page 66) -61 10-32 interal thread, -63 threaded collet, -64 5/16 in - 24 thread



Cat. No.	Termination	Free Speed (rpm)	Type Housing	Weight	Length	Head Height	Air Inlet Size
15LN287-62	1/4" - 28 i	320	Composite	2.5 lb   1.13 kg	12.0 in   305 mm	1.0 in	1/4 in
15LN286-62	1/4" - 28 i	540	Composite	2.5 lb   1.13 kg	13.5 in   343 mm	1.0 in	1/4 in
15LN285-62	1/4" - 28 i	1,000	Composite	2.5 lb   1.13 kg	12.0 in   305 mm	1.0 in	1/4 in
15LN284-62	1/4" - 28 i	1,530	Composite	2.5 lb   1.13 kg	12.0 in   305 mm	1.0 in	1/4 in
15LN283-62	1/4" - 28 i	1,850	Composite	2.5 lb   1.13 kg	12.0 in   305 mm	1.0 in	1/4 in
15LN282-62	1/4" - 28 i	3,100	Composite	2.5 lb   1.13 kg	12.0 in   305 mm	1.0 in	1/4 in
15LN281-62	1/4" - 28 i	5,000	Composite	2.5 lb   1.13 kg	12.0 in   305 mm	1.0 in	1/4 in
15LN288-62	1/4" - 28 i	5,600	Composite	2.5 lb   1.13 kg	12.0 in   305 mm	1.0 in	1/4 in

All tools performance rated @ 90 psi / 620 kPa air pressure.

Standard Equipment: 600 Series Mini Angle Head with 1/4"-28 internal thread

## 15LS Series - Heavy Duty Head

350 - 3,800 RPM 0.6 hp (0.45 kW)

- Wide array of speeds, head designs, and spindle threads for all applications
- High-efficiency motor and gear train
- Comfortable and ergonomic handle
- Other terminations available (see page 67) -51 10-32 interal thread, -53 threaded collet, -54 5/16 in - 24 thread



Cat. No.	Termination	Free Speed (rpm)	Type Housing	Weight	Length	Air Inlet Size
15LS287-52	1/4" - 28 i	350	Composite	2.8 lb   1.27 kg	12.3 in   312 mm	1/4 in
15LS286-52	1/4" - 28 i	590	Composite	2.8 lb   1.27 kg	12.3 in   312 mm	1/4 in
15LS285-52	1/4" - 28 i	950	Composite	2.8 lb   1.27 kg	12.3 in   312 mm	1/4 in
15LS283-52	1/4" - 28 i	1,410	Composite	2.4 lb   1.09 kg	11.0 in   279 mm	1/4 in
15LS282-52	1/4" - 28 i	2,360	Composite	2.4 lb   1.09 kg	11.0 in   279 mm	1/4 in
15LS281-52	1/4" - 28 i	3,800	Composite	2.4 lb   1.09 kg	11.0 in   279 mm	1/4 in

All tools performance rated @ 90 psi / 620 kPa air pressure.

Standard Equipment: 500 Series Heavy Duty Angle Head with 1/4"-28

## 15LN Series - Heavy Duty Head

320 - 3,900 RPM 0.9 hp (0.67 kW)

- Wide array of speeds, head designs, and spindle threads for all applications
- High-efficiency motor and gear train
- Comfortable and ergonomic handle
- Other terminations available (see page 66) -51 10-32 interal thread, -53 threaded collet, -54 5/16 in - 24 thread



Cat. No.	Termination	Free Speed (rpm)	Type Housing	Weight	Length	Air Inlet Size
15LN286-52	1/4" - 28 i	540	Composite	3.0 lb   1.36 kg	12.8 in   325 mm	1/4 in
15LN285-52	1/4" - 28 i	870	Composite	3.0 lb   1.36 kg	12.8 in   325 mm	1/4 in
15LN284-52	1/4" - 28 i	1,070	Composite	3.0 lb   1.36 kg	12.8 in   325 mm	1/4 in
15LN283-52	1/4" - 28 i	1,300	Composite	2.6 lb   1.18 kg	11.5 in   292 mm	1/4 in
15LN281-52	1/4" - 28 i	3,500	Composite	2.6 lb   1.18 kg	11.5 in   292 mm	1/4 in
15LN288-52	1/4" - 28 i	3,900	Composite	2.6 lb   1.18 kg	11.5 in   292 mm	1/4 in

All tools performance rated @ 90 psi / 620 kPa air pressure.

Standard Equipment: 500 Series Heavy Duty Angle Head with 1/4"-28

# Base Modular Quick-Change Tools

320 - 5,300 RPM

15LF: 0.4 hp (0.3 kW); 15LN: 0.9 hp (0.7 kW)

- Quick-release for range of angle head attachments
- Can be used for quick-change of: cutter size, drilling speed, head style
- Pull-back sleeve to change angle head
- Common drive system



Cat. No.	Termination	Speed		Weight	Length	Air Inlet Size
		w/ Q5X Head	w/ Q4X, Q6X, Q7X, Q9x Head			
15LF281Q	Quick Change Adapter	3700	5300	0.4 hp / 0.3 kW	0.65 kg / 1.43 lbs	1/4 in
15LF282Q	Quick Change Adapter	2800	4000	0.4 hp / 0.3 kW	0.65 kg / 1.43 lbs	1/4 in
15LF283Q	Quick Change Adapter	2300	3300	0.4 hp / 0.3 kW	0.65 kg / 1.43 lbs	1/4 in
15LF284Q	Quick Change Adapter	1700	2400	0.4 hp / 0.3 kW	0.65 kg / 1.43 lbs	1/4 in
15LF285Q	Quick Change Adapter	700	1000	0.4 hp / 0.3 kW	0.65 kg / 1.43 lbs	1/4 in
15LF286Q	Quick Change Adapter	525	750	0.4 hp / 0.3 kW	0.65 kg / 1.43 lbs	1/4 in
15LF287Q	Quick Change Adapter	420	600	0.4 hp / 0.3 kW	0.65 kg / 1.43 lbs	1/4 in
15LN281Q	Quick Change Adapter	3500	5000	0.9 hp / 0.7 kW	1.05 kg / 2.31 lbs	1/4 in
15LN282Q	Quick Change Adapter	2170	3100	0.9 hp / 0.7 kW	1.05 kg / 2.31 lbs	1/4 in
15LN283Q	Quick Change Adapter	1300	1850	0.9 hp / 0.7 kW	1.05 kg / 2.31 lbs	1/4 in
15LN284Q	Quick Change Adapter	1070	1530	0.9 hp / 0.7 kW	1.05 kg / 2.31 lbs	1/4 in
15LN285Q	Quick Change Adapter	870	1240	0.9 hp / 0.7 kW	1.05 kg / 2.31 lbs	1/4 in
15LN286Q	Quick Change Adapter	540	770	0.9 hp / 0.7 kW	1.05 kg / 2.31 lbs	1/4 in
15LN287Q	Quick Change Adapter	320	460	0.9 hp / 0.7 kW	1.05 kg / 2.31 lbs	1/4 in

# Quick-Change Angle Heads

350 - 3,800 RPM 0.6 hp (0.45 kW)

- Use with 15LFQ & 15LNQ Base modular quick change tools
- 45°, 90° and 360° light duty angle head: 600 Series
- Heavy duty angle head: 500 Series, drill chuck
- Compact angle head: 700 Series



Ordering Code	Termination	Type	Notes
302206PT-Q42	1/4 in - 28	45° Light Duty Angle Head	
302206PT-Q43	Collet (9/32 in - 40)	45° Light Duty Angle Head	*Order Collets Separately: See pg. 67
302206PT-Q52	1/4 in - 28	Heavy Duty Angle Head - 500 Series	
302206PT-Q53	Collet (9/32 in - 40)	Heavy Duty Angle Head - 500 Series	*Order Collets Separately: See pg. 67
302206PT-Q59	3/8 in - 24	Heavy Duty Angle Head - 500 Series	
302206PT-Q62	1/4 in - 28	Light Duty Head - 600 Series	
302206PT-Q63	Collet (9/32 in - 40)	Light Duty Head - 600 Series	*Order Collets Separately: See pg. 67
302206PT-Q72	1/4 in - 28	Compact Angle Head - 700 Series	
302206PT-Q73	Collet (9/32 in - 40)	Compact Angle Head - 700 Series	*Order Collets Separately: See pg. 67
302206PT-Q92	1/4 in - 28	360° Light Duty Angle Head	
302206PT-Q93	Collet (9/32 in - 40)	360° Light Duty Angle Head	*Order Collets Separately: See pg. 67

## Optional Drill Attachments

For use on Dotco 15LF, 15LS, and 15LN series. Capacity: 1/4" Diameter Drill

These drill attachments can be ordered as a separate accessory item or as part of a complete model. To order as a complete model, use the basic model number from the appropriate 15LF, 15LS, or 15LN catalog page and replace the termination number (-32 for example) with the termination number of the desired optional attachment (-71 for example) from this page.

Part Number	Termination	Spindle Thread
<b>Compact Angle Head – 700 Series</b>		
1025477	-72	1/4"-28 Internal Thread
1025476	-73	9/32"-40 Internal Thread*
1025668	-74	5/16"-24 Internal Thread
<b>Light Duty Head – 600 Series</b>		
1025314	-61	#10-32 Internal Thread
1025409	-62	1/4"-28 Internal Thread
1025313	-63	9/32"-40 Internal Thread*
1025328	-64	5/16"-24 Internal Thread
<b>Heavy Duty Angle Head – 500 Series</b>		
1021289	-52	1/4"-28 Internal Thread
1021292	-53	9/32"-40 Internal Thread*
1021291	-54	5/16"-24 Internal Thread
1025780	-55	3/8"-24 Internal Thread
<b>45° Light Duty Angle Head</b>		
1025730	-42	1/4"-28 Internal Thread
1025731	-43	9/32"-40 Internal Thread*
1025733	-44	5/16"-24 Internal Thread
<b>360° Light Duty Angle Head</b>		
1025696	-91	#10-32 Internal Thread
1025694	-92	1/4"-28 Internal Thread

\* 9/32-40 thread for collets, see page 67



1021289



1025447



1025730



1025409



1025694



1021620

Part No.	Termination	Drill Chuck
<b>Heavy Duty Angle Head</b>		
1021620	-59	500 Series Angle Head with drill chuck, 1/4" capacity
1021620	-59 NC	500 Series Angle Head, no chuck 3/8"-24 ext. thread

## Straight Shank Drill Adaptors

For use on Dotco 15LF, 15LS & 15LN right angle drills with 1/4"-28 spindles. (Termination codes: -42, -52, -62, -72, & -92). Adapts 1/4" - 28 output to collet/chuck for straight shank drills.

Type	Size	Assembly	Adaptor Only	Collet Only	Length	Hex Size Body/Nut
Mini Threaded Collet	1/8"	14-1102	14-1568	14-0158	0.65"	.437 / .375
Mini Threaded Collet	1/4"	14-1104	14-1569	14-0168	0.7"	.500/.437
Mini Threaded Collet	6mm	14-1094	14-1569	14-0170	0.7"	.500/.437
Mini Collet Nut	3/16"	863810	N/A	N/A	0.8"	.500/.500
Mini Collet Nut	1/4"	863806	N/A	N/A	0.8"	.500/.500
Cone Jaw Chuck	.040" - 1/4"	1020699	N/A	N/A	0.9"	0.75/0.75

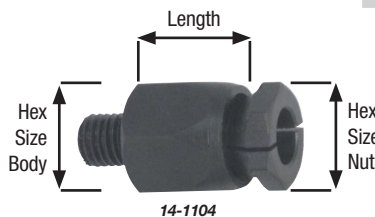

14-1104

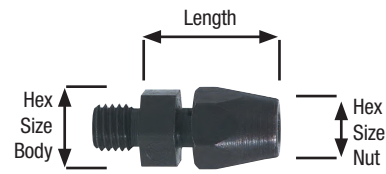

863810

## Collets

For use on Dotco 15LF, 15LS & 15LN right angle drills with 9/32"-40 spindles.

1005184



(Termination codes: - 43, -53, -63, -73, & -93)

Cat. Number	Drill Size		
	No.	Inch Decimal	mm
1006408	53	0.0600	
316PT		0.0630	1.6
1005180	1/16	0.0630	
1006412	51	0.0670	1.7
320PT		0.0787	2
1005875	46	0.0810	
1005182	3/32	0.0940	
324PT		0.0945	2.4
1005684	40	0.0980	
325PT		0.0984	2.5
1006395	39	0.1000	
326PT		0.1024	2.6
1005183	7/64	0.1090	
330PT		0.1181	3
1005873	31	0.1200	
331		0.1220	3.1
1005184	1/8	0.1250	
332PT		0.1260	3.2
1013904	30	0.1290	
333PT		0.1299	3.3
1005185	9/64	0.1410	
1005872	27	0.1440	
1005186	5/32	0.1560	
1005926	22	0.1570	
340PT		0.1575	4
1005682	21	0.1590	
1005876	20	0.1610	
341PT		0.1614	4.1
342PT		0.1654	4.2
1006035	19	0.1660	
1005187	11/64	0.1720	
1005977	17	0.1730	
344PT		0.1732	4.4
345PT		0.1772	4.5
1005927	13	0.1850	4.7
1005188	3/16	0.1880	
348PT	12	0.1890	4.8
1006001	11	0.1910	
349		0.1929	4.9
1005681	10	0.1940	
350PT		0.1969	5

Other sizes available, please contact Cleco Production Tools

## Chuck Assemblies (300 Series Collet)

Size	Chuck Assembly	Thread	L
3/16"	14-3050-12	3/8"-24	2.62"/66.5mm
7/32"	14-3050-14	3/8"-24	2.62"/66.5mm
1/4"	14-3050	3/8"-24	2.62"/66.5mm
1/4"	14-1148	5/16"-24	1.62"/41.2mm
3/32"-1/4" *	14-3080	3/8"-24	2.12"/54mm



## Jacobs® Chucks

Part No.	Type	Capacity	mm	Term.
1005078	With Key	1/4 in	6.3	3/8 in - 24
1001505	With Key	1/4 in HD	6.3	3/8 in - 24
1001252	With Key	3/8 in	9.5	3/8 in - 24
1009726	With Key	1/2 in	12.7	3/8 in - 24
33633	Keyless	5/16 in	8.0	3/8 in - 24
33663D	Keyless	25/64 in	10.0	3/8 in - 24



1001252

## 300 Series Collet Chuck

Use with Standard Collet: 1/4" (#308).  
Termination Number: -36



Part Number	Description
14-1148	1/64"-1/4" capacity with a 5/16"-24 female thread

## Quick-Change Chuck

Thread Size	Capacity	Part Number
3/8"-24	1/4" Hex	QRA-08



## 300 Series Collets

Size	Cat No
3/32"	303PT
1/8"	304PT
3/32"	305PT
3/16"	306PT
7/32"	307PT
1/4"	308PT
3mm	311PT
6mm	310PT

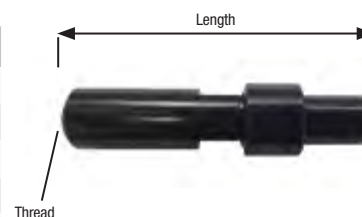

## Drilling Guides - Manual

These drill guides, simple and sturdy, can be fitted with a removable drill bush of tempered high-speed steel. The drill bush is slide fit to H7g6 with a m6 fit on the last 3 mm.

Drilling Guides	Code Number
Tripod RB 240	70300005
Quadripod RB 245	70300010



## Drilling Bushes

For Use with Drilling Guides - Manual

We can supply all drilling bushes from 0.039 in up to 0.47 in dia.

All our bushes are manufactured with a tolerance of +0.0006 in / +0 on the nominal diameter.



### How to order

For  $\leq 0.3933$  in

Example :

Bush 0.1275 in dia  
Mini dia 0.1275 in dia  
Maxi dia 0.1281 in dia

Basic Code

7031

+

Collet dia in mm

3.24

70310324

Code to indicate

### How to order

For dia 0.3937 in to 0.4724 in

Example :

Bush 0.4468 in dia  
Mini dia 0.4468 in dia  
Maxi dia 0.4474 in dia

Basic Code

7031

+

Collet dia in mm

11.35

70311135

Code to indicate

## Cutter Adapters

For M6, M8, and M10 Cutters

Adaptors to use threaded cutters in drill chucks.

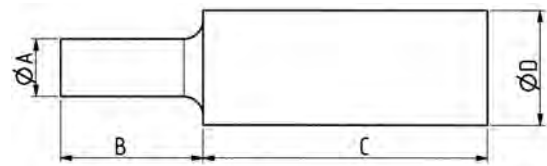

For Cutter Thread	Ø A		B mm	C mm	Ø D mm	Code
	mm	in				
M6 x 1	4	0.157	15	15	10	10090000
M6 x 1	6	0.236	20	30	10	10090050
M8 x 1	6	0.236	20	30	12	10090055
M8 x 1	8	0.315	20	30	14	10090100
M10 x 1	10	0.394	20	30	14	10090150

## Flat Offset Angle Drill

For restricted access drilling. Fits into a standard drill chuck, shaft size is 6mm

Cutter Attachment	A	B	Code
UNF 10-32 F	84	28	10080005
	84	112.5	10080010
	63	28	10080015
	63	112.5	10080020



## Drill Cutters for Flat Offset Angle Drill

FOR USE WITH	ALUMINIUM	STEEL	TITANIUM	COMPOSITE
HSS	●			

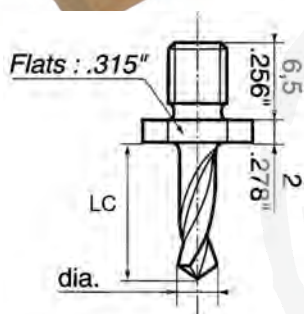

LC	DRILL DIAMETER		PART NUMBER	
	mm	in		
2.5	0.0984	12	0.472	33000020
2.5	0.0984	20	0.787	33000625
3	0.1181	12	0.472	33000025
3.2	0.126	8	0.315	33000132
3.2	0.126	12	0.472	33000030
3.2	0.126	20	0.787	33000632
4	0.1575	12	0.472	33000040
4	0.1575	15	0.591	33000240
4.8	0.189	15	0.591	33000248

Alternative drills may be manufactured on request.  
E.g. special diameters and lengths.

## Countersink Cutters for Flat Offset Angle Drill

HSS UNF 10-32F

FOR USE WITH	ALUMINIUM	STEEL	TITANIUM	COMPOSITE
HSS	●			

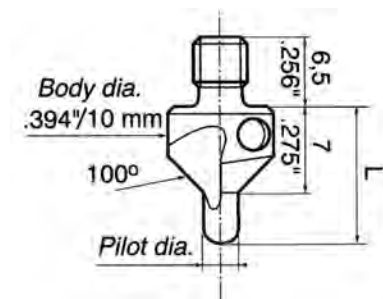

L	PILOT DIAMETER		PART NUMBER	
	mm	in		
9.40	0.370	1.60	0.0630	33001005
10.60	0.417	2.40	0.0945	33001010
10.75	0.423	2.50	0.0984	33001015
11.60	0.456	3.20	0.1260	33001020













## Microstop Cages



Microstop Cage	Shank Dia.	Cutter Thread	Stroke	Ø EXT. MAXI	Total Length	
					Mini	Maxi
RB 156	Ø 4.8 mm - 0.19 in dia	M6 x 1	3.5 mm - 0.14 in	Ø 25 mm - 1 in dia	51 mm - 2 in	55 mm - 2.16 in
RB 206	Ø 6 mm - 0.24 in dia	M6 x 1	6 mm - 0.24 in	Ø 21 mm - 0.826 in dia	95 mm - 3.74 in	101 mm - 3.97 in
RBI 206	Ø 6 mm - 0.24 in dia	1/4 in - 28 F	6 mm - 0.24 in	Ø 21 mm - 0.826 in dia	95 mm - 3.74 in	101 mm - 3.97 in
RB 256	Ø 6 mm - 0.24 in dia	M6 x 1	7.5 mm - 0.3 in	Ø 28 mm - 1.1 in dia	91 mm - 3.58 in	98 mm - 3.85 in
RBI 256	Ø 6 mm - 0.24 in dia	1/4 in - 28 F	7.5 mm - 0.3 in	Ø 28 mm - 1.1 in dia	91 mm - 3.58 in	98 mm - 3.85 in
RB 257	Ø 6 mm - 0.24 in dia	M6 x 1	6 mm - 0.24 in	Ø 29 mm - 1.14 in dia	88 mm - 3.46 in	92 mm - 3.62 in
RB 258	Ø 6.35 mm - 1/4 in dia	M6 x 1	27 mm - 1.06 in	Ø 29 mm - 1.14 in dia	141 mm - 5.55 in	156 mm - 6.14 in
RBI 258	Ø 6.35 mm - 1/4 in dia	1/4 in - 28 F	27 mm - 1.06 in	Ø 29 mm - 1.14 in dia	141 mm - 5.55 in	156 mm - 6.14 in
RB 306	Ø 6 mm - 0.24 in dia	M8 x 1	7.5 mm - 0.3 in	Ø 28 mm - 1.1 in dia	91 mm - 3.58 in	98 mm - 3.85 in
RB 307	Ø 6 mm - 0.24 in dia	M8 x 1	7 mm - 0.28 in	Ø 29 mm - 1.14 in dia	88 mm - 3.46 in	98 mm - 3.62 in
RBI 307	Ø 6 mm - 0.24 in dia	1/4 in - 28 F	7 mm - 0.28 in	Ø 29 mm - 1.14 in dia	88 mm - 3.46 in	98 mm - 3.62 in
RB 406	Ø 6 mm - 0.24 in dia / JTI	M10 x 1	14 mm - 0.55 in	Ø 36 mm - 1.42 in dia	136 mm - 5.35 in	163 mm - 6.42 in
RB 356 HP 21	Ø 6 mm - 0.24 in dia / JTI	M6 x 1	21 mm - 0.83 in	Ø 27 mm - 1.06 in dia	116 mm - 4.57 in	136 mm - 5.35 in
RB 356 HPI 21	Ø 6 mm - 0.24 in dia / JTI	1/4 in - 28 F	21 mm - 0.83 in	Ø 27 mm - 1.06 in dia	116 mm - 4.57 in	136 mm - 5.35 in
RB 356 HP 38	Ø 6 mm - 0.24 in dia / JTI	M6 x 1	38 mm - 1.5 in	Ø 27 mm - 1.06 in dia	183 mm - 7.2 in	168 mm - 6.61 in
RB 356 HPI 38	Ø 6 mm - 0.24 in dia / JTI	1/4 in - 28 F	38 mm - 1.5 in	Ø 27 mm - 1.06 in dia	183 mm - 7.2 in	168 mm - 6.61 in
RB 356 HP 58	Ø 6 mm - 0.24 in dia / JTI	M10 x 1	58 mm - 2.28 in	Ø 38 mm - 1.5 in dia	264 mm - 10.4 in	292 mm - 11.5 in
RB 356 HPI 58	Ø 6 mm - 0.24 in dia / JTI	7/16 in - 20 F	58 mm - 2.28 in	Ø 38 mm - 1.5 in dia	264 mm - 10.4 in	292 mm - 11.5 in

**A wide range of cutters are available for use with Dotco Pistol Grip Drills.**

For product information refer to SP401 Aerospace Products Catalogue.

<p>Cutters with Inserted Pilot for Countersinking for Rivets and Screws in HSS, Carbide and PCD M6 and M8 threads 10-25mm Diameter with 3-12mm pilots</p>	
<p>Cutters with Inserted Pilot for Countersinking for Rivets and Screws in HSS, Carbide and PCD M6 and M8 threads 12-25mm Diameter with 5-14mm pilots</p>	
<p>Spotfacing Cutters with Pilot Insert in HSS, Carbide and PCD M6 and M8 threads 6-38mm Spotface</p>	
<p>Drill and Countersink Cutters in HSS, Carbide and PCD</p>	
<p>Drill, Ream and Countersink Cutters in HSS, Carbide and PCD</p>	
<p>Tapered Drill Reamers</p>	
<p>Fluted Drill Reamers</p>	
<p>Router Cutters</p>	
<p>Wire Brush for Rivet Holes</p>	



Kompania Narzędziowa  
"HERMES" Sp. z o.o.

ul. Sarni Stok 73 a, 43-300 Bielsko-Biała, Polska  
tel: +48 33 821 41 90-91 [www.hermestools.eu](http://www.hermestools.eu)